

Firewise Construction

DESIGN AND MATERIALS



Colorado
State
FOREST
SERVICE



Firewise Construction

DESIGN AND MATERIALS

Peter Slack



First edition printing, 1999

Revised printing, 2000

To obtain copies of this publication contact the
Colorado State Forest Service at
970-491-6303 or online at csfs.colostate.edu



About the Author

Peter Slack of Boulder, Colorado was a practicing architect for 26 years, until his untimely death in June 2000. Peter's practice included many homes and other buildings in the Interface. His design emphasized the integration of fire-resistive elements with other important design principles such as proper site development for limited impact, low energy and water consumption, and the use of appropriate, resource conserving materials.

Peter was a firefighter and an officer in a high-risk mountain fire district for 19 years. He specifically worked with wildland fire suppression and mitigation issues for much of that time. After fighting Boulder County's two major interface fires, Black Tiger, 1988 and Olde Stage, 1990, Peter participated in Boulder County's WHIMS Program (Wildfire Hazard Identification and Mitigation System). FEMA funded the WHIMS program as a result of those fires. This publication is developed from a lecture on firewise construction that Peter presented for several years.

Acknowledgements

This publication combines Peter's professional knowledge as an architect and builder in the Interface with his experience as a firefighter for 19 years. Added to his experiences is the wealth of information and experience so generously given by the firefighting community. Most of all, it was their assistance in learning to visualize fire in its environment and around our buildings that facilitated the creation of these illustrations.

The following people contributed to this pamphlet by providing a wealth of information.

Dr. Claire Hay, consultant, Wildfire Interface Group

Mark Mulinex, Wildland Fire Coordinator, City of Boulder Fire Dept.

Mike Tombolato, chief, Cherryvale Fire Protection District

The many members of the Boulder County WHIMS program, who over many years have developed, to this date, one of the most comprehensive and systematic approaches to understanding the hazards of wildland fire to homes in the Interface.

The following people helped make this publication possible. They were responsible for choosing the author and providing additional technical details and editing:

Frank C. Dennis, Colorado State Forest Service

Fred Sibley, Office of Emergency Management, State of Colorado

The following people assisted in the production of this document:

Karen Gerhardt, Westerly Design, layout and design

Chris White, Wildfire Mitigation Coordinator, Boulder County

Gillans Engineering, Colorado, editing, second printing

Jill Croft Slack, editing and support

Table of Contents

| | |
|--|-----------|
| 1. Introduction: | 1 |
| What is the Wildland Urban Interface? | |
| Fire suppression and increased fuels | |
| How can we protect our buildings? | |
| Fire intensity and duration related to the fire resistance of a house | |
| Evaluating fire hazards | |
| 2. Fire Behavior: Fuels, Topography and Weather | 5 |
| Wildland fires and burning structures | |
| Vegetation is the fuel for wildland fires | |
| Fire duration and fuel | |
| Fire behavior and slope | |
| Fire behavior, ignition of fuels: mechanisms of heat transfer | |
| Convective lifting | |
| indirect: convective heating | |
| radiant heating | |
| Direct contact or impingement | |
| Weather | |
| 3. Building Site Location | 9 |
| Topography and vegetation: fire behavior and intensity | |
| Aspect | |
| Dangerous topographic features: areas of more intense fire behavior | |
| Natural barriers and buffer zones | |
| How this affects building location and design decisions | |
| Site design and modifications to the forest: developing a defensible space | |
| 4. Building Design | 15 |
| Simple vs. complex forms | |
| Aspect ratio | |
| Vents, eaves, soffits and decks | |
| Decks | |
| 5. Building Materials and Components | 25 |
| Ratings | |
| Roofing | |
| Siding | |
| Windows and glass | |
| Doors | |
| 6. Summary | 37 |
| References and additional information | |

I. Introduction

This publication provides homeowners and builders in the Wildland Urban Interface with design and building techniques that can offer more protection from wildland or forest fires. The Federal Emergency Management Agency (FEMA), the Colorado State Forest Service and the Colorado Office of Emergency Management funded this project.

What is the Urban Wildland Interface?

The Urban Wildland Interface, or Interface, is any area where man-made buildings are built close to or within natural terrain and flammable vegetation, where high potential for wildland fires exists.

During the past few decades, population growth in the Interface has increased. Subdivisions and other high-density developments have created a situation where a wildland fire can involve more buildings than any amount of fire equipment can possibly protect.

Fire suppression and increased fuels

The past 100 years of wildland fire and suppression has created more vegetation for fuel.

As population in the Interface has increased, so too has the difficulty of protecting that population from wildland fires. When fires occur in the Interface, we put them out to prevent the destruction of homes. This creates a problem because forests have historically depended on fire to maintain good

health. Fire thins trees and brush and eliminates dead material. By suppressing fires to protect our homes and population, we have interfered with this natural process. Since natural fires are now infrequent, vegetation density has increased, which provides more fuel for fires. When fires do occur, the denser vegetation burns with more intensity, and the fire is more destructive and dangerous.

How can we protect our buildings?

This publication offers a two-part approach to the problem:

1. Build more fire-resistive structures and
2. Reduce the hazards of forest fuels.

If we consider the specific needs of Interface structures, we can combine design elements and construction materials to build more fire-resistive structures. Our goal is to create buildings that can either resist fire on their own, or at least make it easier for firefighters to protect structures safely.

We recognize that building a fireproof structure, as we do in an urban setting, can be prohibitively expensive. This publication discusses how to consider a combination of cost effective strategies that increase the probability of a building surviving a wildland fire.



Combustible house with no defensible space

Solutions to problems in the Interface depend on a two-part approach: Make our buildings more fire resistive and manage the surrounding wildlands. If we leave the surrounding wildland in its current state, we need to build structures that are nearly fireproof. Fireproof structures are far too expensive to build. Conversely, trying to provide a defensible space large enough for a typical, combustibile structure may not be practical or desirable. Choosing the best combination of these two strategies for a particular site requires a basic understanding of wildland fire behavior.

Another goal of this publication is to give the homeowner and builder a better understanding of how buildings in the Interface ignite during a wildland fire. With this information they can make better choices when considering building techniques and materials.

When reading this publication keep in mind that fire is only one of many considerations during building construction. We are not suggesting that any one technique is absolutely necessary, or that you cannot use alternate materials or design elements.

Rather, we want to show you how an awareness of the unique issues facing Interface buildings can direct you toward a more comprehensive solution in the design process. Some design elements and materials may help mitigate fire hazards; and some may not. It is possible, however, to compensate for less appropriate fire protection choices and meet design goals.

Fire intensity and duration related to the fire resistance of a house

How fire resistive should a house be? The answer to this question depends on the fire intensity, (how hot the fire burns), and the fire duration, (how long the fire will last a your site). If the fire hazard is low to moderate, only a few precautions may be needed. If the fire hazard is high or very high, most, or all, of the strategies we describe may be needed.

In Colorado, generally any area surrounded by natural vegetation faces some hazard due to wildland fires. In mountainous regions between elevations of 5,000 and 10,000 feet, hazard is increased due to topography and increased vegetation density. The next section discusses this in more detail.

Evaluating fire hazards

A good way to determine the specific hazard rating at a site is to look at a fire hazard map or study located at the county building or land use department. The Colorado State Forest Service or your local fire protection district may also have information. If this information is not immediately available, use this short evaluation to determine a site's hazard level.

Note: We refer to this hazard rating throughout this publication with respect to design and material elements in building design.

This short evaluation is based on the Wildland Home Fire Risk Meter developed by the National Wildfire Coordinating Group (www.nwccg.com).

| Slope | Score |
|-----------|-------|
| Level: | 0 |
| 0° - 10° | 1 |
| 10° - 20° | 2 |
| 20° - 30° | 3 |
| 30°+ | 4 |

Vegetation

| | |
|---|---|
| water, bare rock, irrigated lawn | 0 |
| grass, shrub, less than 2 feet tall, no trees | 1 |
| grass, shrub, less than 4 feet widely dispersed trees | 2 |
| dense young shrubs, no dead wood or trees | 2 |
| many trees, touching, some grass and brush | 3 |
| dense shrubs with some trees | 3 |
| thick, tall grass | 3 |
| dense evergreen trees with grass and shrubs | 4 |
| dense mature shrub with dead branches | 4 |

After selecting the appropriate slope and vegetation scores, add them together to determine the hazard rating.

| Scores | Hazard Rating |
|--------|---------------|
| 0 | 0 |
| 1 - 2 | low |
| 3 - 4 | medium |
| 5 - 6 | high |
| 7 - 8 | very high |

2. Fire Behavior: Fuels, Topography and Weather

Wildland fires and the nature of burning structures

Wildland fires have been studied in great detail to help predict fire behavior. Anticipating the intensity, duration and movement of a wildland fire is very important for both firefighter safety, and as the basis of tactical decisions made during the suppression of a fire.

Understanding fire behavior, especially its intensity and duration at a building site, will help homeowners and builders decide how fire-resistive a house needs to be.

Three factors affect wildland fire behavior:

1. **The fuel for the fire.** The type, continuity and density of the surrounding vegetation provides fuel to keep the fire burning.
2. **The topography of the site.** The steepness of slopes and other land features affects the fire behavior.
3. **The weather.** Wind and humidity affect each fire.

Vegetation is the fuel for wildland fires

The type and density of a specific plant determines how it will burn. Not all vegetation burns the same way. Some vegetation almost never burns; others burn at different times of the year; and some can burn almost anytime.

Deciduous trees and bushes: Trees such as aspen, cottonwood and mountain ash; bushes such as mountain maple and dwarf lilac usually burn only during severe droughts.

Bushes, such as the Gambel oak, serviceberry and sage, can burn either in the fall when leaves have changed or dropped, or when there is an extended dry period.

Evergreen trees with resinous sap:

Pines, spruce and firs can burn any time of year. They usually burn during extended dry weather or high wind events.

Evergreen bushes: Cedar and juniper can also burn any time of year when conditions are dry.

Grasses. Grasses can burn any time of the year and only need a short dry period before they are receptive to fire. Grass is fire resistive only when it is very green or a good snow cover exists.

Fire duration and fuel

Fire duration is how long a fire will burn at a particular site. The type of fuel and its density determines a fire's duration. For example, grass is a light fuel. It will burn in less than five minutes and produce relatively less heat than heavier fuels would produce. Medium fuels, such as brush, burn five to 10 minutes with more heat. Large trees are considered heavy fuels because they burn from 10 minutes to over an hour with the most heat.

Understanding this is very important to determine how long a house must

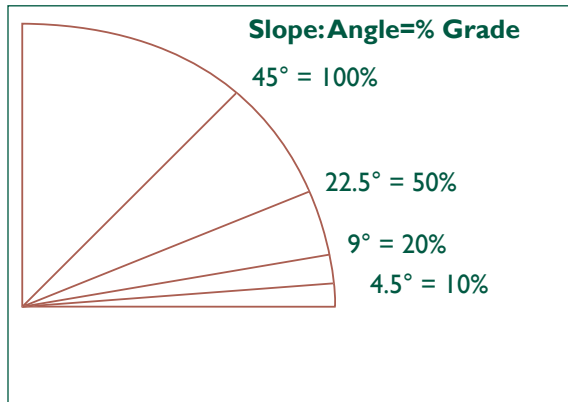

Slope chart

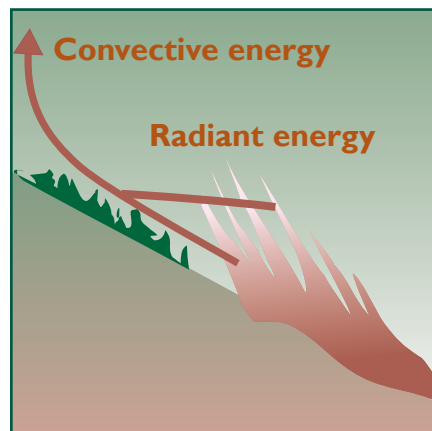

Convective and radiant energy from a fire

resist a fire. Different building materials can resist fire for different time periods.

Fire behavior and slope

Slope is the angle of the ground relative to the horizon. It is commonly measured in either degrees or as a percent. Slope topography shows the steepness of the slope and the shape of the land.

The steeper the slope, the more quickly a fire moves and the hotter it burns.

For example, **a fire will spread twice as fast on a 30 percent slope than it will on level ground.**

This means that a house located on a steep slope needs more fire resistance.

Fire behavior, ignition of fuels: mechanisms of heat transfer

As a fire burns, it releases hot gas and air from the combustion of burning vegetation or buildings. These gases move up the slope, drying and preheating any vegetation in the fire's path. The fire also releases large amounts of radiant energy, like that of the sun, which also heats and dries the fuels. Once flames make contact with these plants, they ignite more easily. This in turn speeds up the rate at which the fire moves and increases its intensity. Look more closely at the mechanisms of fire and how fire ignites a building by studying three categories of heat transfer:

1. indirect convective heating and lifting
2. indirect radiant
3. direct contact or impingement.

Convective lifting

Fire produces hot gases that rise and carry partially burned substances and smoke into the atmosphere. During a wildland fire this atmospheric effect can be very strong, even causing its own wind as cooler air rushes in to replace the rising hot air.

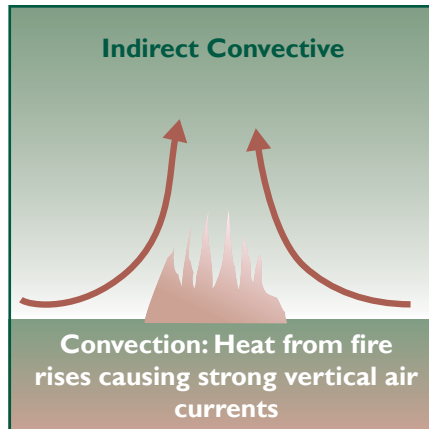

Convective lifting

Convective vertical air currents can also lift burning materials or embers, called firebrands, and carry them horizontally for long distances from the fire.

Once out of the rising air currents, firebrands fall back to the ground and onto horizontal surfaces such as combustible roofs, decks and dry vegetation around a house. This effect, called spotting, can be very widespread. Firebrands often travel hundreds or even thousands of feet in front of the actual fire.

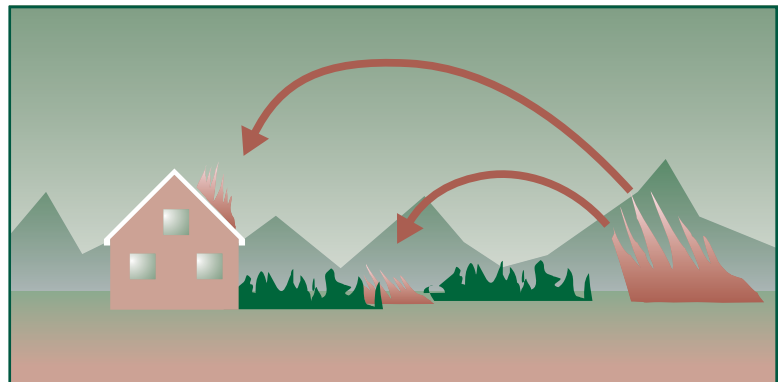

Firebrands, transported by convective lifting, create spot fires

Indirect: Convective Heating

The same hot air and gasses that dry and preheat vegetation do the same thing to a building, making any combustible materials ready to ignite once the fire gets closer.

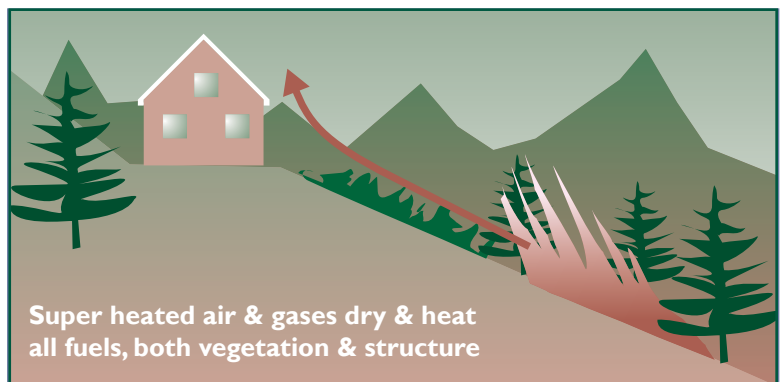

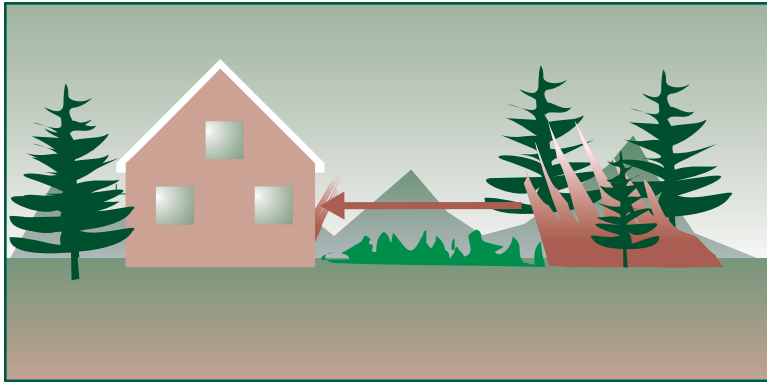

Radiant heating

Indirect: radiant heating

Buildings can be preheated, even ignite and burn, from the transfer of heat by radiant energy from the fire. This is similar to sunlight heating objects, but fire heats only in the infrared portion of the light spectrum. Radiant heat transfers on a straight line of sight and can be reduced by barriers.

Vertical surfaces, such as siding, can ignite from this effect well before fire actually reaches the building. Large heavy fuels, once ignited, burn with high temperatures that amplify radiant energy, creating more potential for ignition through heat transfer.



Fire directly impinging on a house

Direct contact or impingement

Continuous and abundant fuels like those found in unmanaged vegetation areas provide a direct path for a fire to contact a building. Creating defensible space and fuel breaks around a building is specifically intended to reduce this effect.

Weather

Weather is a major factor affecting fire behavior and is, of course, highly variable in terms of time, intensity and location. During extended periods of low moisture, the possibility of wildfire increases. Weather can also increase and intensify fire behavior when there is low humidity and high winds.

Colorado's fire season is highly variable. Typically, winter and spring have few

wildfires; summer and fall have more wildfires. However the period between winter and spring, after the snow has melted but the vegetation has not yet greened, is often a period of high fire occurrence.

Colorado typically has 50 to 100 days a year of critical fire weather when severe wildfires are possible. More "fire days" occur at lower elevations while fewer "fire days" occur at higher elevations.

3. Building Site Location

Topography and vegetation: fire behavior and intensity

The location of a structure will influence the intensity and duration of the fire to which it is exposed. As discussed in the fire behavior section, we know at any location how intense a fire will be; how long it will be there; and how fast it will travel, based on the surrounding topography and vegetation.

When choosing a site location or determining the level of fire resistance a building requires, the builder or homeowner should be aware of how the local vegetation and topographic variations affect fire behavior.

Aspect

Aspect is the direction that a site's slope faces. Vegetation varies widely between the extremes of south facing and north facing slopes.

South slopes tend to have the least vegetation in an area because they quickly dry out and have less available moisture for plants. Since there is less fuel on south facing slopes, fire burns with less intensity than on other slopes with more fuel.

East and west slopes generally have more vegetation than south slopes. They are more prone to drying out in the summer when the sun is high in the sky. Fire potential increases on these slopes during the summer season.

North slopes typically have the most dense vegetation because there is more water available for plants. The higher moisture content of the vegetation on north slopes means that fires occur there less frequently. However, when fires do occur, they burn with more intensity because there is more fuel.

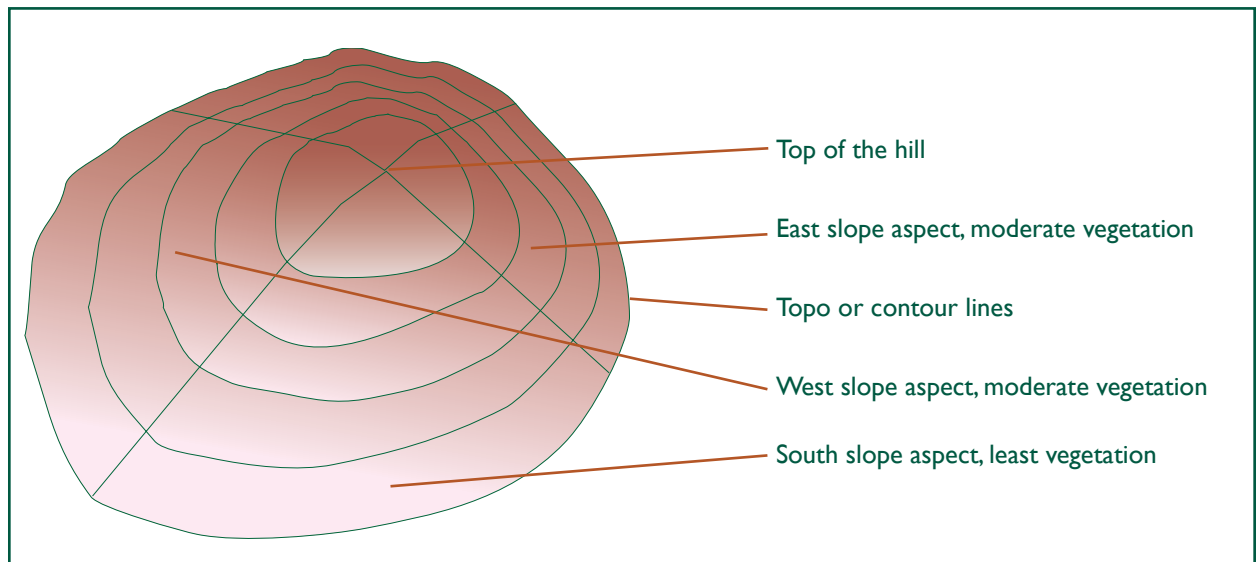

Aspect of slope

Dangerous topographic features: areas of more intense fire behavior

Variations of topographic features such as valleys, ridges, canyons and saddles can be dangerous areas that further intensify or attract a fire.

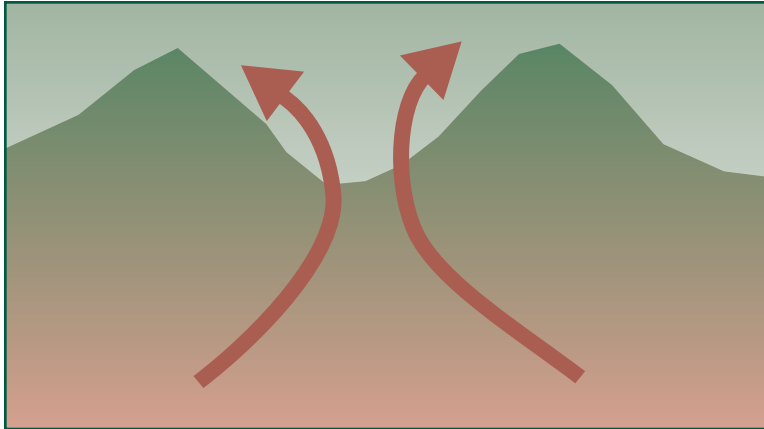

Saddle, low area on a ridge

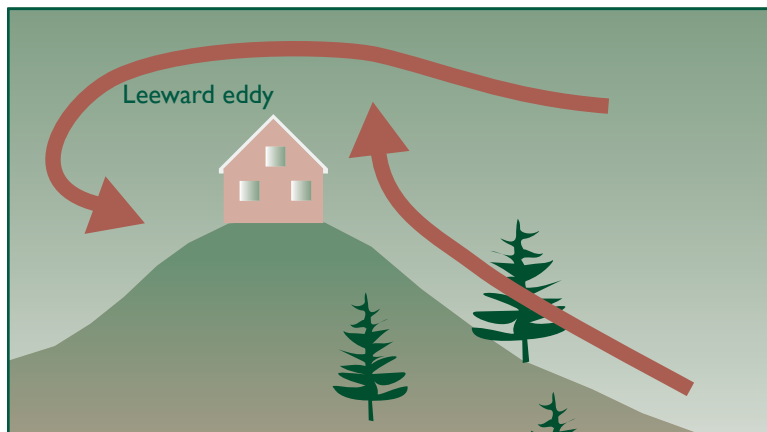

Ridge with wind exposure

A **valley**, as a concave form, tends to collect and concentrate winds. This means that a wildland fire's intensity increases as it moves through a valley. If the valley is narrow with steep sides, such as a **canyon**, this effect is more pronounced.

When a valley crosses a ridge it creates a **saddle** between the higher parts of that ridge. Like a valley, saddles will channel, intensify and speed up a fire. These areas tend to be built upon because they offer some shelter and often flat areas. It is important to recognize that saddles are natural fire paths where fire will travel first, and with more intensity.

Ridges experience more wind primarily because they are elevated above the surrounding land. When a fire moves up a slope toward a ridge, it gathers speed and intensity.

As the wind crosses a ridge it usually has a leeward eddy where the wind rolls around and comes up the leeward side, exposing both sides of the structure to wind and fire. There are usually no areas on ridges to provide protection from the fire.

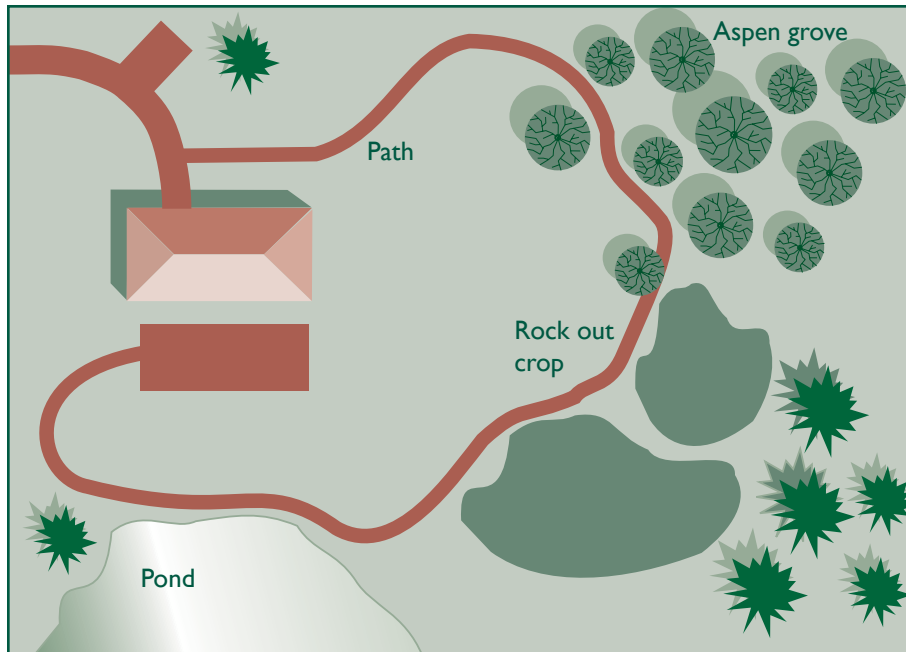

Site: House located relative to natural features that buffer against fire

Natural barriers and buffer zones

Some physical features will reduce fire behavior and can be used to slow, reduce or deflect a fire. Some examples of these beneficial barriers are natural rock outcroppings, wetlands, streams, lakes and deciduous tree stands, (aspen, cottonwood, etc). Take advantage of these features by placing a building so that the natural barrier is between the building and the anticipated path of a fire.

the primary consideration will depend on how high the fire hazard is in the area.

On smaller parcels there may be only one suitable building location. The site's physical features will determine the probable fire intensity and dictate what combination of site modifications and fire-resistant construction is necessary to prevent the building from igniting.

How this affects building location and design decisions

On large parcels of land consider these physical features when choosing the final location of a building. Many other factors such as privacy, views, access and aesthetic values will also effect site location decisions. Fire is just one of these factors. Whether or not fire is

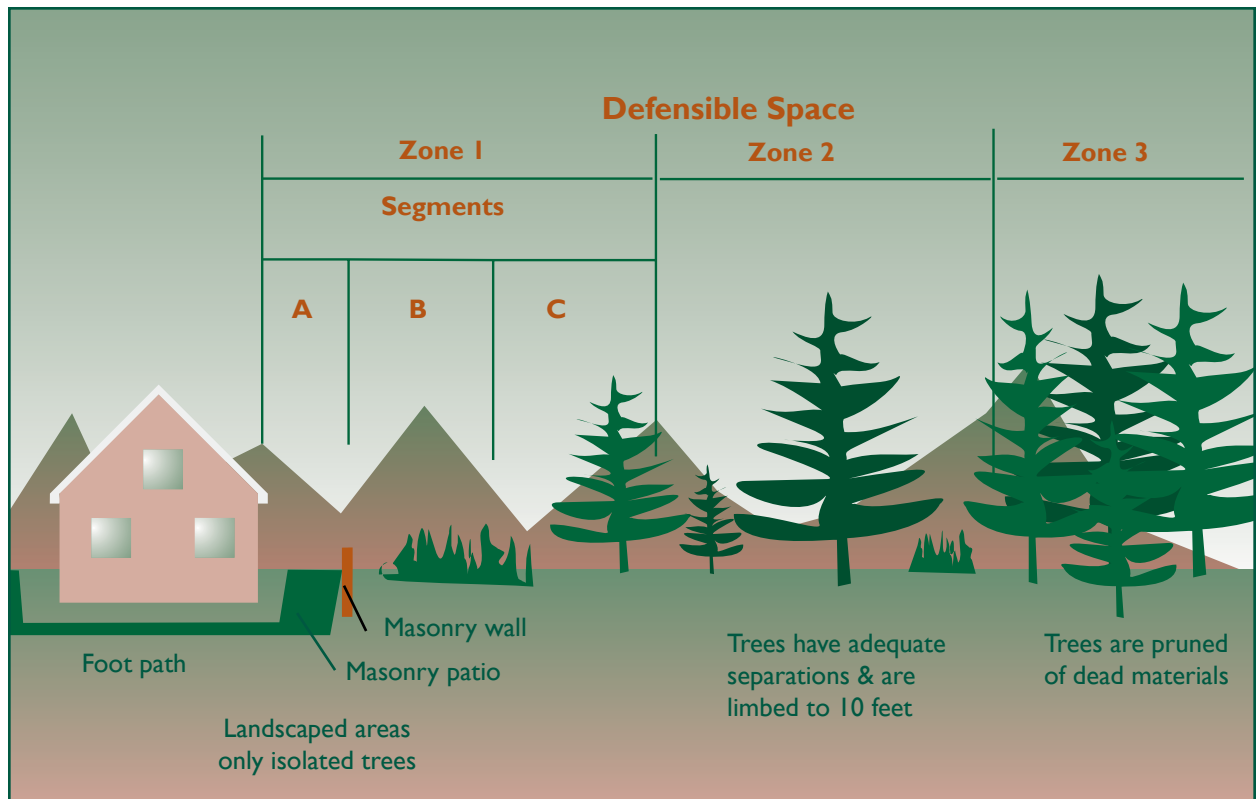

Defensible space

Site design and modifications to the forest: developing a defensible space

After evaluating the fire hazard rating of a site, develop a plan to manage the surrounding forest and defensible space. This is the first part of our two-part strategy to build a fire-resistant structure. **Defensible space** is the area around a building that has been significantly modified to reduce a wildfire's intensity just enough to prevent the fire from igniting the house. The defensible space will also allow firefighters to more safely defend the house. It can also help prevent a house fire from spreading to surrounding vegetation.

A diagram of the features at a building site would show that moving away from

the building out into the wildland, the features gradually shift from man-made to more natural elements. We divide this gradation into zones. Developing a defensible space plan requires an inventory of the existing site features and analysis of how hazardous they are. Man-made elements are landscaping features such as masonry walls, patios, footpaths and driveways. These features create barriers and buffer zones.

The area next to the building (Zone I-A) should contain primarily noncombustible surfaces. Any planting in this zone should be only deciduous, well-trimmed and irrigated. Ground covers should be flowerbeds and cut grass.

Moving away from the building, the next area (Zone I-B) can have more

landscaping and less man-made surfaces. Vegetation should still be deciduous trees, bushes and grass can be native, but they must be kept trimmed to fewer than 6 inches tall.

Moving farther away from the building to (Zone 1-C) the landscaping should change from introduced deciduous plants to natural vegetation, including evergreens. These trees or bushes should be far apart and well maintained by trimming.

In Zone 2 the landscape is entirely natural vegetation that is intensely managed or modified. Trim dead material from natural vegetation closest to the buildings. Prune all limbs to 10 feet above the ground. Thin trees so that a minimum of 10 feet separates the tree crowns.

Moving vegetation farther away from the building into Zone 3, the forest management gradually becomes less intensive and subtler. Tree limbs need to be pruned only 4 to 5 feet above

the ground. Tree crowns can be closer together.

Remember, the more intensive and wide-ranging modifications you make in the defensible space, the less the need for fire-resistive materials and building design. Conversely, fewer modifications to the surrounding wildland increase the need to use fire-resistive materials and design for the building. These two strategies work together to achieve the goal of building a firewise structure that does not burn when wildfires occur.

4. Building Design

So far we have discussed elementary fire behavior and how to manage the wildlands surrounding an Interface building. The second part of our approach to building fire-resistive structures is learning about appropriate design and material choices.

Simple vs. complex forms

Simple building forms have less surface area relative to the volume of the building. Complex building forms have much more surface area relative to volume. Simple building forms are less expensive to build, more energy efficient and easier to protect from wildland fires. There is simply less exterior surface to protect.

Complex forms not only increase the surface area of the structure, but also create shapes that trap the fire's heat. These areas are called heat traps. Transitions between vertical surfaces and horizontal surfaces, inside corners between two walls or abrupt intersections of different solid planes form pockets where wind velocity drops and eddies form.

Parapet walls, solar collectors, roofs intersecting walls, roof valleys and decks are examples of heat traps.

These forms cannot be avoided, and their locations require much more attention to fire-resistive materials.

When wind speed decreases burning embers falls most often at the locations described above.

Roofs are very susceptible to firebrands in a wind driven fire.

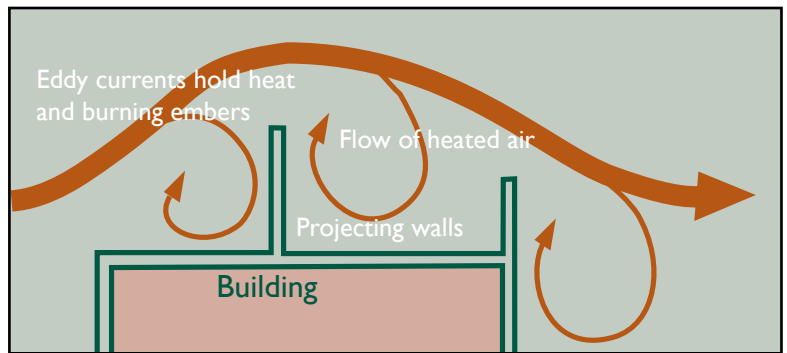

Heat traps around walls

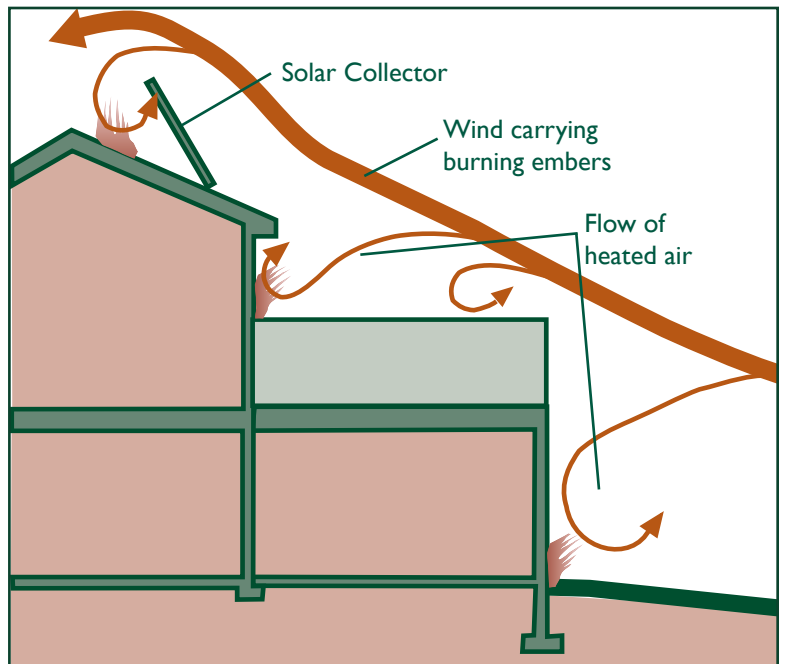

Heat traps around roofs

A simple roof form such as a hip or straight gable is best. Complicated roofs with intersecting planes and valleys form dead air pockets and eddy currents. The use of complicated forms further highlights the importance of a truly fire-resistive roof.

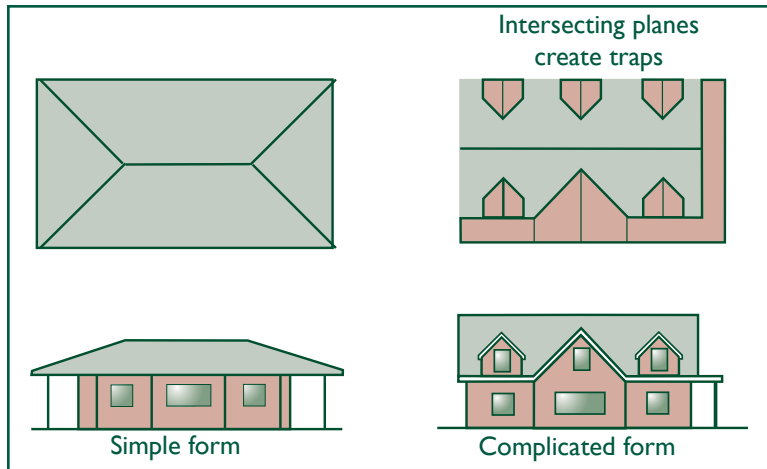

Roof forms

Aspect ratio

Aspect ratio is the ratio between the east-west axis and the north-south axis. In Colorado's climate it is generally better to have a structure that is longer on the east-west axis than the north-south axis. Such a structure has a more favorable energy relationship with the

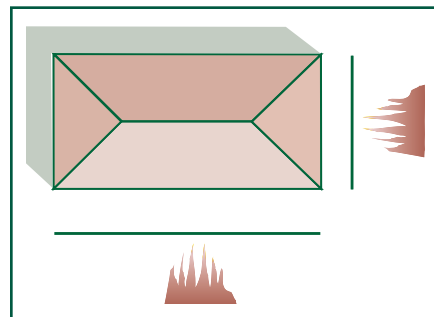

climate and can gain the benefits of the sun's passive solar heat.

With regard to fire, if a house presents its widest exterior in the direction from which a fire is likely to come, it will be more vulnerable. More fire-resistant materials and components are needed on the side that faces the oncoming

fire. On a flat site the direction of a fire is somewhat unpredictable, but it will generally be determined by the predominant winds and fuel.

The probable fire path is more easily predicted on sloping sites. Fire can be expected to approach up the slope. On east and west facing slopes, placing the building on the longer east-west axis works well for both energy and fire considerations. The building presents its widest side to the winter sun and its narrowest side to the fire path.

Remember, a building can contradict these principles. In that case the building will require more fire-resistant building materials and components when simple forms and optimum aspect ratios cannot be used.

Vents, eaves, soffits and decks

Building a fire-resistant house can be compared to building a watertight roof. One little hole in the roof allows water to leak in, and it doesn't matter how well the job was done on the rest of the roof, it failed and damage occurred.

Small building elements like soffits and vents can be the weak link in a fire. An otherwise fire-resistant house is damaged or destroyed because fire found a way in through these areas.

Vents

Vents are required by the building code to prevent accumulation of water vapor. All crawl spaces under wood floors are required to have ventilation. One square foot of vent is required for

every 150 square feet of floor area. Since these vents are typically located near the ground, care should be taken to not have any combustible vegetation immediately next to them.

Vents located on the downhill side of the house should have landscaping elements like stone patios or walls that block the direct path of the fire. Building codes typically allow alternatives to traditional vents. In some cases louvered vents are permitted. These can be closed when moisture is not a problem. (Fire season is usually the dry season.) Mechanical ventilation with intakes and exhaust located away from the ground or other vulnerable locations can also be used.

All attic spaces and roof cavities are required to have ventilation. One square foot of vent is required for every 300 square feet. of roof. (See eaves and soffits on page 18.) In both cases the vents should be made of metal with wire screen material that has 1/4 inch or smaller openings.

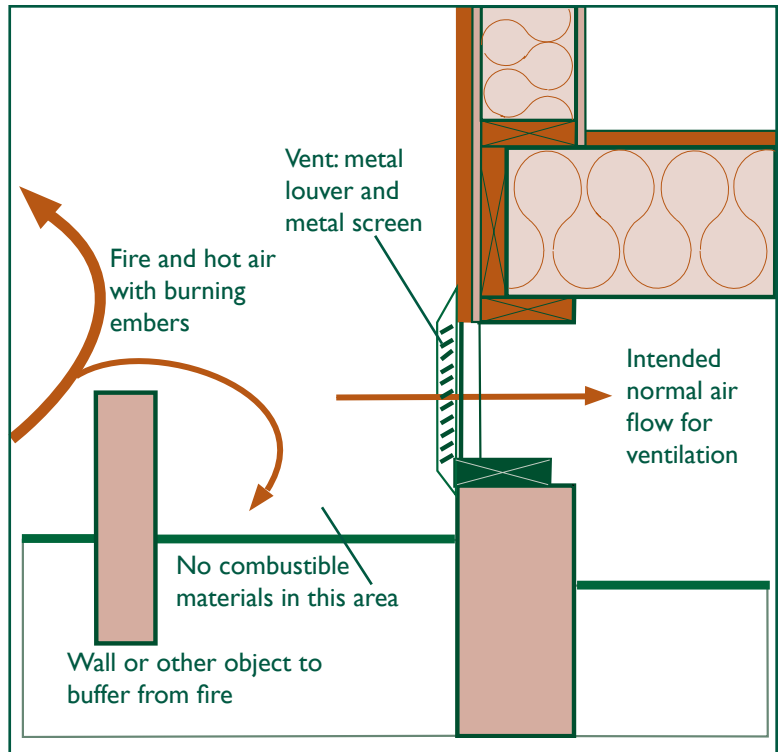

Crawl space ventilation

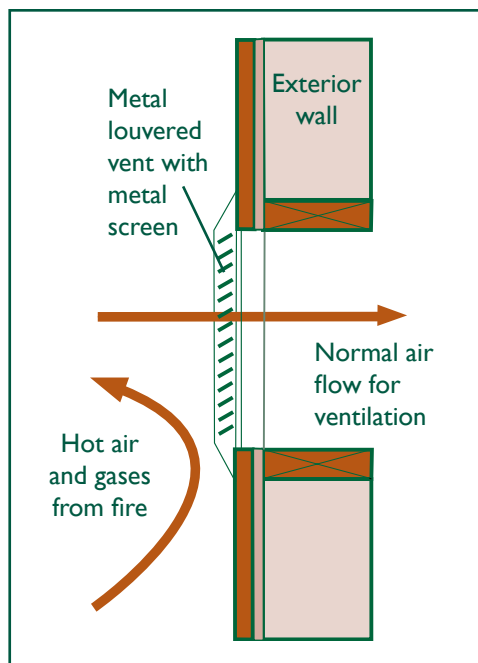

Attic Vent

Eaves and soffits

The extension of the roof beyond the exterior wall is the eave. This architectural form is particularly prone to ignition. As fire approaches the building, the exterior wall deflects the hot air and gasses up into the eave. If the exterior wall is combustible this effect is amplified.

The solution is to cover the eave with a soffit. If the soffit is applied directly to the rafter eave, it forms a sloping soffit. This still makes a pocket that can trap fire.

A better detail is to form a flat soffit that allows the building to more readily deflect fire outward.

The soffit material should be at least 3/4 inch plywood in low fire hazard areas, noncombustible in moderate and high areas, and one-hour rated material in very high hazard areas.

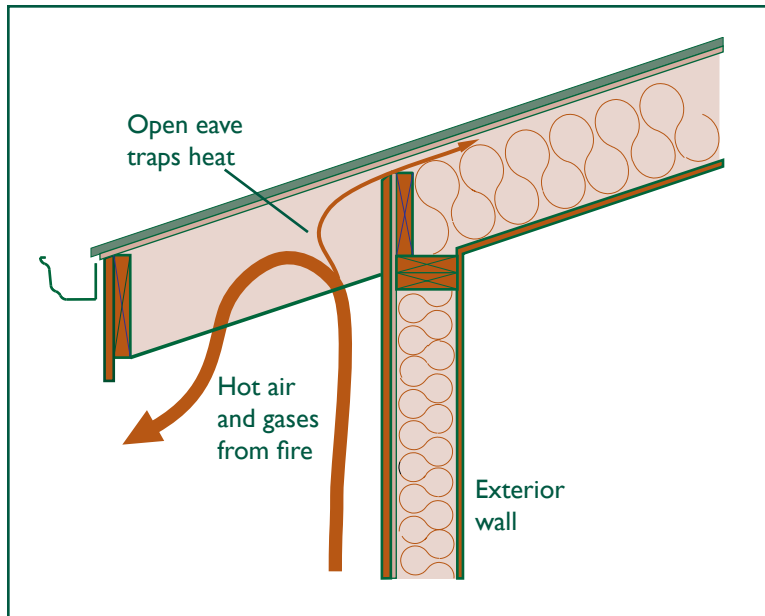

Open eave with no soffit

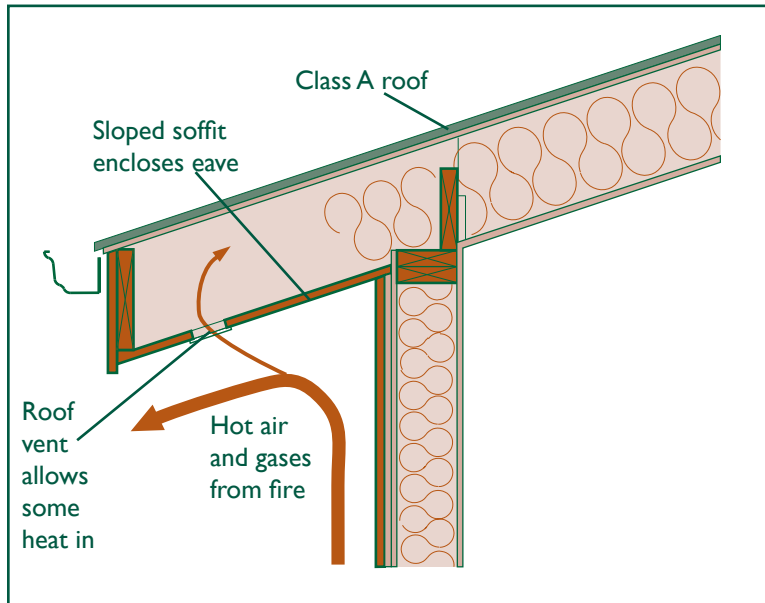

Open eave with soffit

Vents for roof ventilation are often found in the soffit. **Placing vents in these locations creates a perfect path for fire to enter the roof structure.** If the vent must be in this location it is better to place it farther from the wall and closer to the fascia. The vent can also be placed in the fascia or near the lower edge of the roof.

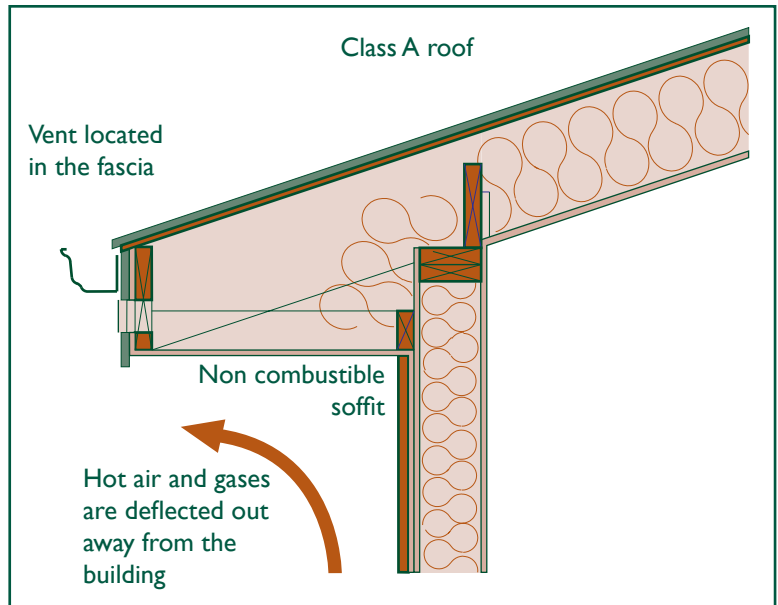

Fully enclosed soffit with isolated vent

Decks

Decks are a very popular and well-used part of the house, especially in mountainous terrain. Because they provide elevation above the terrain and surrounding vegetation, they offer a better view. They also supply flat areas for walking on otherwise sloping terrain.

The problem is that most decks are highly combustible structures. They are the ultimate heat traps. Their shape traps hot gasses from an approaching fire. Decks often face downhill towards a fire's most likely approach up a slope.

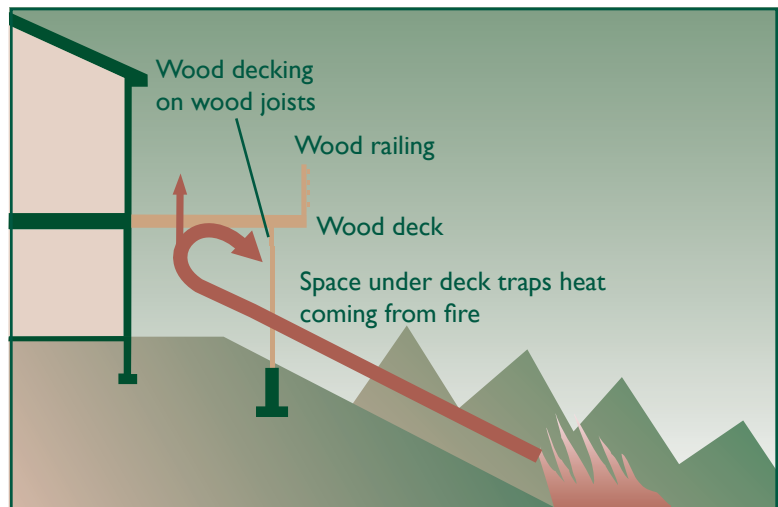

Conventional deck in a fire

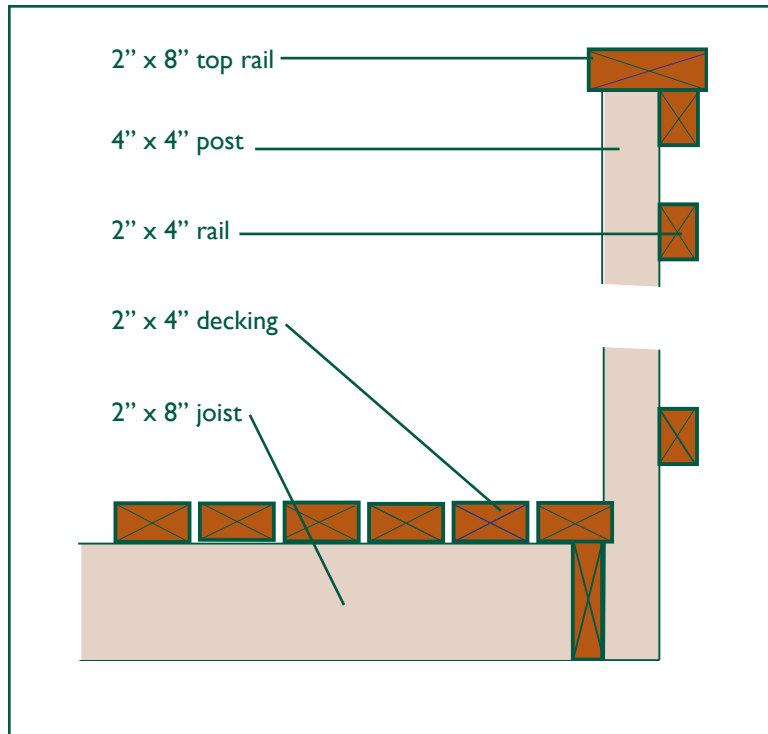

Conventional deck construction detail



Decks are built perfectly to burn, almost as easily as wood stacked in a fireplace. All the components of a deck; joists, decking and railings, are made of only 2 inch thick wood with a high surface-to-volume ratios.

When fire approaches, the wood quickly dries out and heats up. Ignition can occur very easily when either the radiant energy from the fire gets hot enough or a burning ember lands on it.

Ignition of decks

Conventional wood decks are so combustible that when wildland fire approaches, the deck often ignites before the fire gets to the house. Sometimes unburned vegetation exists between the house and the fire, demonstrating that the deck was more flammable than the vegetation.

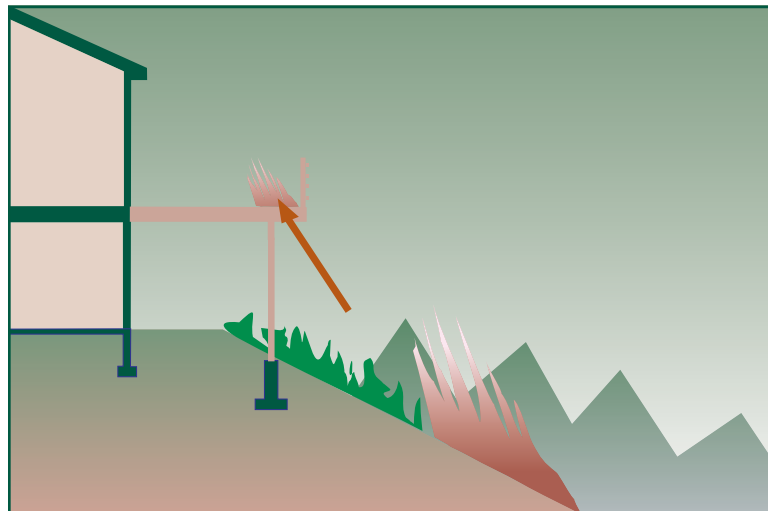

Isolate the deck from the fire with a patio and a wall

In low and moderate fire areas, it may be sufficient to isolate the deck from the fuels and fire by building a noncombustible patio and wall below it. The patio will assure that no combustible materials are below the deck. The wall will act as a shield, deflecting both the radiant and convective energy of the fire.

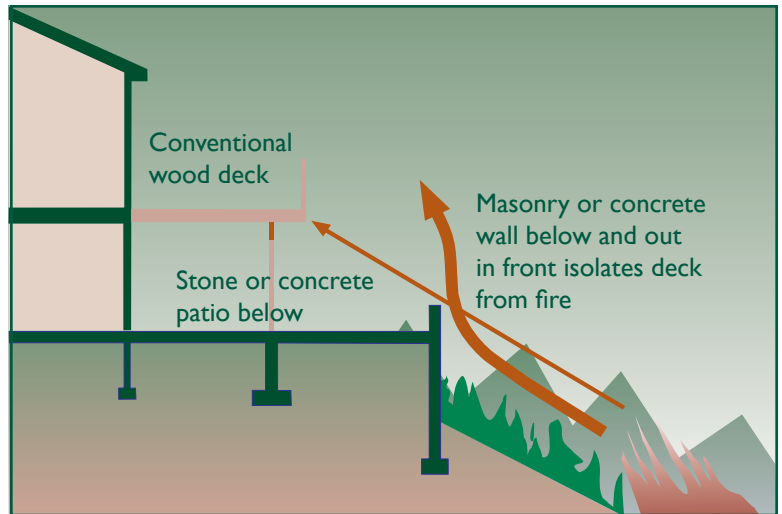

Deck with a patio and a wall below

Heavy timber construction

In moderate hazard areas the use of heavy timber construction is acceptable. Like log siding, heavy timber is combustible but so thick that it burns very slowly.

Minimum thickness for a heavy timber deck is 6 inches for the posts and structural members and 3 inches for the decking and rails. This type of construction can be used with a patio below for additional protection.

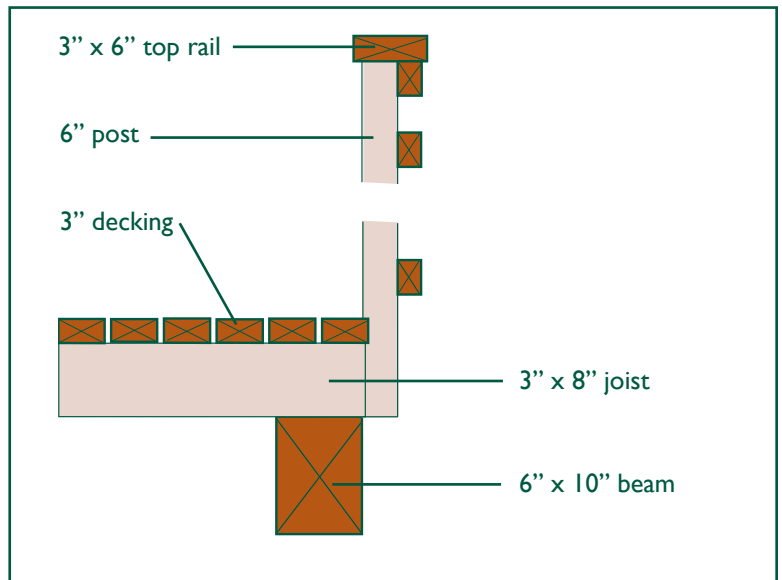

Heavy timber deck

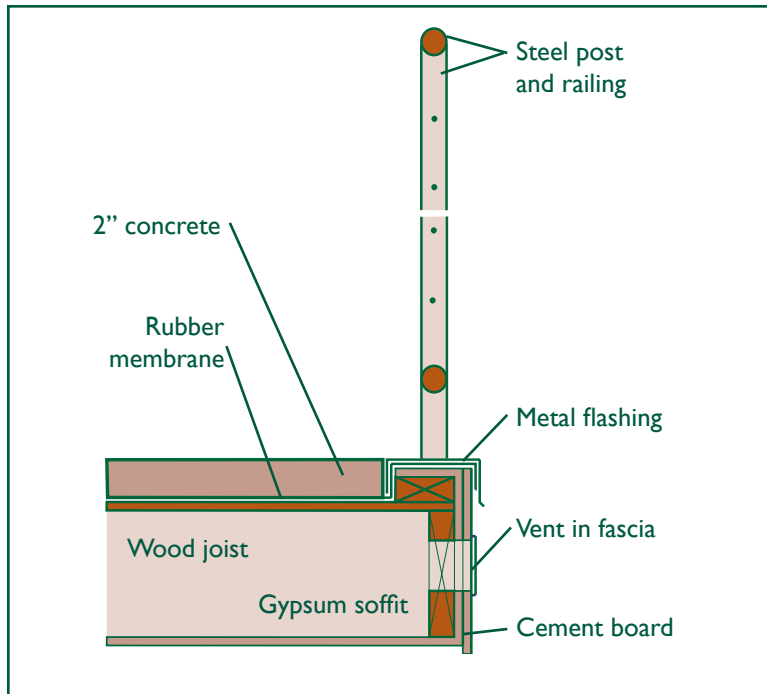

Fire-resistant deck construction detail

Fire-resistant deck construction

In the highest fire hazard areas, consider noncombustible surfaces and fire-resistant building materials for a deck. Wood frame construction is permitted, but change the surface to noncombustible or one-hour rated materials.

To build this type of surface, place a waterproof membrane over the top of the deck. This allows the use of fire-resistant soffit materials, which cannot tolerate moisture. The most common materials are cement fiber panels or metal (noncombustible), or gypsum (noncombustible and one-hour rated).

Cover the membrane with decking. One suggestion is plastic wood which has low combustibility; it will burn but only very slowly. Better yet, use 1 to 2 inches of concrete or stone. This surface is fire-proof and protects the deck from air-born firebrands. However, this covering requires that the structure be strengthened to support the additional weight.

Posts and railings can be economically built from steel. Wood posts near the ground can have stone, brick, or noncombustible coverings. A popular baluster design is steel wire, but this is expensive. Steel pipe, usually 1 to 2 inches in diameter, is very economical and easy to work with. Square steel shapes can look like traditional wood railings.

Fully enclosed decks

The best design is to convert the deck to a solid form by fully enclosing it. This completely eliminates the heat trap. This form also complies with the new Urban/Wildland Interface code (1997).



In the photo above, the deck is over the garage. It has a metal railing with heavy timber posts and concrete deck.

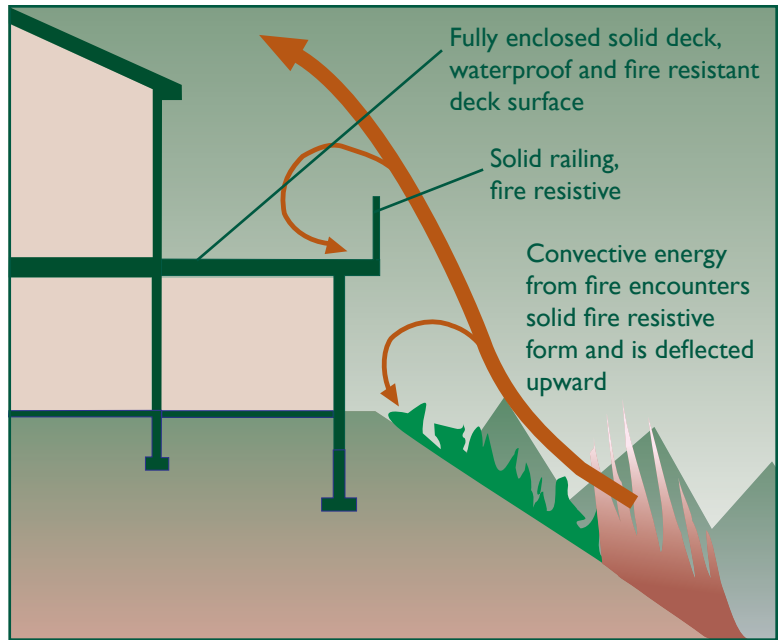

Fully enclosed solid deck

5. Building Materials and Components

Ratings

When discussing building materials and components we make frequent references to ratings. Through testing various national organizations provide ratings or evaluations for the fire resistivity of materials or building assemblies. A building assembly is a combination of materials forming a component of a building such as a roof or wall. The ratings are in the following categories:

Combustible or noncombustible

Classes: A (best), B, and C

Time: 20 minute, one-hour, two-hour and four-hour

The organizations that provide these ratings are: the International Conference of Building Officials (ICBO) through its publication, the Uniform Building Code (UBC); Also a founding member of the International Code Council (ICC) through its publication the International Building Code (IBC); The American Society for Testing and Materials (ASTM); the Underwriters Laboratory (UL); and the National Fire Protection Association (NFPA).

The difference between a non-combustible material and a rated material or assembly is the surface resistance to ignition versus the protection afforded the building behind it. A good example of a non-combustible material is metal roofing and siding. Metal is non-combustible, but an excellent conductor of heat. If the fire remains present long enough, the heat will be conducted through the metal and ignite the material behind it. An example of

a fire-rated assembly is wood siding applied over gypsum sheathing. This assembly is rated as one hour. The surface can ignite, but the building is protected from the fire for one hour.

The importance of this is the difference between intensity of fire and duration of fire as described in the fire behavior section.

Most ratings are for commercial buildings in urban settings, but some apply to residential structures. For example, the wall between a garage and a house must be rated as one-hour fire resistive. The door between the garage and the house must have a “C label” rated for 20 minutes with an automatic closer.

Material ratings for the wildland fire environment have been directly addressed by the I.C.B.O, through a subsidiary, the International Fire Code Institute, Fire Service Division and its publication, the Urban Wildland Interface Code and N.F.P.A. Standard 299. These publications also address other issues covered in this publication such as access, utilities and water supplies for fire suppression. Much of what is contained in this publication is based on or refers to these publications.

Roofing

Roofing is one of the most important ways to protect a house from wildland fire. As shown earlier, when wildland fires become more intense, the lofted firebrands become a significant cause of the fire spread. Since most roofing has a rough surface and numerous cracks, it can trap wind blown embers and firebrands. In all major Interface fires, houses thousands of feet from the fire have been observed with burning roofs.

Wood shakes and shingles

Simply put, wood shakes and shingles are made perfectly to burn. They are almost like kindling. They are thin, 1/2 to 1 inch thick, with a very rough surface and many cracks. When a wood roof burns it also lofts burning embers, contributing to the spread of fire. Another important characteristic of wood roofs is that they dry out in Colorado's dry climate.



A cedar roof can be modified to be fire-resistant. Pressure treatment with chemicals can change wood shingles to a class B or C roof. Chemically treated cedar roofs built with a gypsum underlayment can have a class A assembly rating. However, many doubt that the testing conditions for these shingles matched Colorado's climate of low

humidity, high winds, elevated ultraviolet radiation and extreme temperature variations.

The use of wood shakes in the Colorado region is diminishing, not because of the fire risk they pose, but because of the unavailability of insurance coverage for damage due to hail and high winds. Cost wise, hail losses in Colorado are 10 times greater than fire losses.

Asphalt shingles

Asphalt shingles are probably the most economical way to roof a building, especially in terms of dollars spent per years of guaranteed life. Conventional mineral reinforced asphalt shingles have been around for more than 60 years. They are normally guaranteed for 10 to 20 years, and usually have a class C rating.



Mineral reinforced shingles have gradually been replaced by fiberglass reinforced asphalt shingles. These offer guarantees of 20 to 40 years and are a class A material. They are available in many colors and textures and can even imitate wood or slate shingles.

Metal: sheet and shingles

Metal roofing has always been available in sheet form in many colors. It usually has standing seams or ribs. The most common metal roof is galvanized steel with factory-applied paint (usually a two-part epoxy type, not too different from automobile paint).



Metal roofing is also available as an imitation wood shingle. This product is made by stamping a texture and shape on the metal and then applying the appropriate color. This imitation is so good that at a distance of 100 feet or more it is difficult to tell the difference between it and a wood shingle.

The advantage of metal roofing, both flat and stamped shingle, is that it is non-combustible, durable and very lightweight. It requires a gypsum underlayment in order to have a class A assembly rating, but that is only necessary in high or very high fire hazard situations. Guarantees start at 20 years and go to 50 years.

In addition to galvanized steel with paint, metal roofing is also available in aluminum with paint, stainless steel and copper. These tend to be more expensive but also last longer.

Fiber-cement shingles

These shingles are made of cement and fiberglass, or cement and wood. Like the metal shingle, they are made to imitate a wood shingle's texture, shape and color. The cement in these products is altered with polymers to make it less brittle. These products are also noncombustible but require an underlayment for a class A assembly rating.

Membrane roofs

These materials include both rubber and hot applied, bituminous saturated mineral felt for flat roofs. These materials are marginally combustible but are most often used with other covering systems like concrete. It can be applied over a gypsum underlayment for a class A assembly rating. Guarantees are only in the 10 to 20 year range, but these products can be considered permanent when covered with concrete.

Concrete shingles and tile, slate shingles, clay tile

These products provide the best fire-resistive roof, but they are expensive. They are 1 inch thick, heavy (10 pounds per square foot), non-combustible, class A rated and usually come with 50 year guarantees. Concrete shingles are manufactured to look like wood shingles. When having a tile roof installed, pay careful attention to the closure of the round openings of the tiles at the edge of the roof.



Exterior walls: siding

The exterior walls of a building are most affected by radiant energy from the fire and, if there is not enough defensible space provided, by the direct impingement of the fire.

Wood panels and boards

Wood panels and boards are the most common and economical forms of siding, but they are readily combustible. This siding is usually not very thick, 1/2 inch to 3/4 inch, and will burn through to the structure behind it in less than 10 minutes. A one-hour rating can be achieved by adding gypsum sheathing behind the siding. However, this addition is of limited value because the building can still ignite, and the fire can spread to other parts of the building such as the eaves above the exterior wall or the windows.



Fiber cement panels, boards and shingles

These products are non-combustible, but they may not be rated and may need gypsum sheathing to achieve a one-hour rating. These materials are very economical and cost just a little more than wood products. When these products are applied with the gypsum

sheathing they offer the most economical way to side a house that will resist almost all fire hazard conditions. These materials are virtually permanent on a vertical surface and come with a 50 year guarantee, but they need to be painted. Some can even take a stain with satisfactory results. These products are available with textures molded to imitate wood grain.

Metal: galvanized steel,

aluminum, boards, panels and shingles
Like their counterparts in roofing, these products are available in either flat sheets with seams, a stamped board or shingle that imitates a wood product. They are factory painted with two-part epoxy paint and usually have a 50 year guarantee. Unlike the fiber cement product, the paint on this product is a part of the guarantee; thus, it is an almost permanent, no-maintenance material. It is non-combustible, but like other metal products needs a gypsum sheathing to achieve a one-hour rating.

“Real” Stucco

Real stucco, as base material, is 3/4 inch to 1 inch thick cement and gypsum. The stucco is applied in two or three coats with metal mesh reinforcing. The color is integrated into the final coat and thus lasts a very long time. Guarantees are 10 to 20 years. It is both a non-combustible and one-hour rated material, which makes it a very good material for high hazard areas. Real stucco tends to be expensive and is also prone to cracking if not applied absolutely correctly.

Synthetic stucco, exterior

insulating finish system (EIFS)

This product is a 1/8 inch thick acrylic cement finish on fiberglass mesh. This is applied to the tap surface 1 to 2 inches of expanded polystyrene (EPS). The color, like real stucco, is in the cement coat and thus lasts a long time. This is the preferred way to do stucco because it takes less labor and is therefore cheaper. The foam insulation isolates the stucco finish from the building, which virtually eliminates cracking.

The surface is noncombustible and has no rating by itself. This product is interesting in a fire because it significantly delays a fire due to the insulation quality of the rigid foam and the fact that the system does not ignite; it actually fails and falls away. In moderate to high fire hazard situations this product will work well. It can, like other products, obtain a one-hour rating with gypsum sheathing, which should be used in a very high fire hazard area.

Heavy timber or log construction

This wood product has a minimum thickness of 6 inches for frame members and exterior siding, and



3 inches for decking and steps. Heavy timber is recognized by building codes as a separate fire-resistive category.

Even though heavy timber is combustible, the low surface-to-volume ratio causes it to burn very slowly. This makes it very appropriate for medium and high fire risk situations.

Concrete synthetic stone

These products are cast concrete with integral color forming the texture and shape of the stone being imitated. They are modular shapes that have consistent dimensions with flat backs, keeping labor costs down.



Synthetic stone is reinforced with fiberglass and steel mesh, making it very resistant to cracking. It is fully noncombustible and is usually rated as a one-hour material.

Brick, stone and block

These materials are both permanent and fireproof. Ratings are usually two hours. These are the best products to use in regard to fire resistivity but are the most expensive.

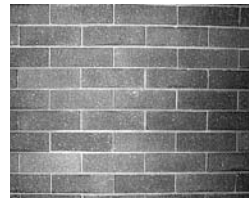

Windows and Glass

Windows are one of the weakest parts of a building with regard to fire. They usually fail before the building ignites, providing a direct path for the fire to reach the building interior.

Glass failure

Glass provides only a partial barrier to fire and only for a short time. It fractures in the presence of heat. In the case of a wildland fire, this will happen in about five minutes. Glass deflects most of the convective energy, but not the radiant energy of the fire.

Convective energy is hot air and gasses. About 70 percent of the heat is deflected by window glass; about 20 percent of the heat is absorbed; and 10

percent of the heat is transmitted to the interior of the building.

Radiant energy from a fire is infrared light energy, like the energy we experience from the sun. Most radiant energy from a fire, 60 percent, is transmitted through the glass to the interior of the building; about 20 percent is reflected; and about 20 percent is absorbed by the window glass.

Both the radiant and convective energy heats the glass, but the perimeter of the glass is covered and protected by a sash. This causes a differential heating and stressing of the glass, which causes it to crack.

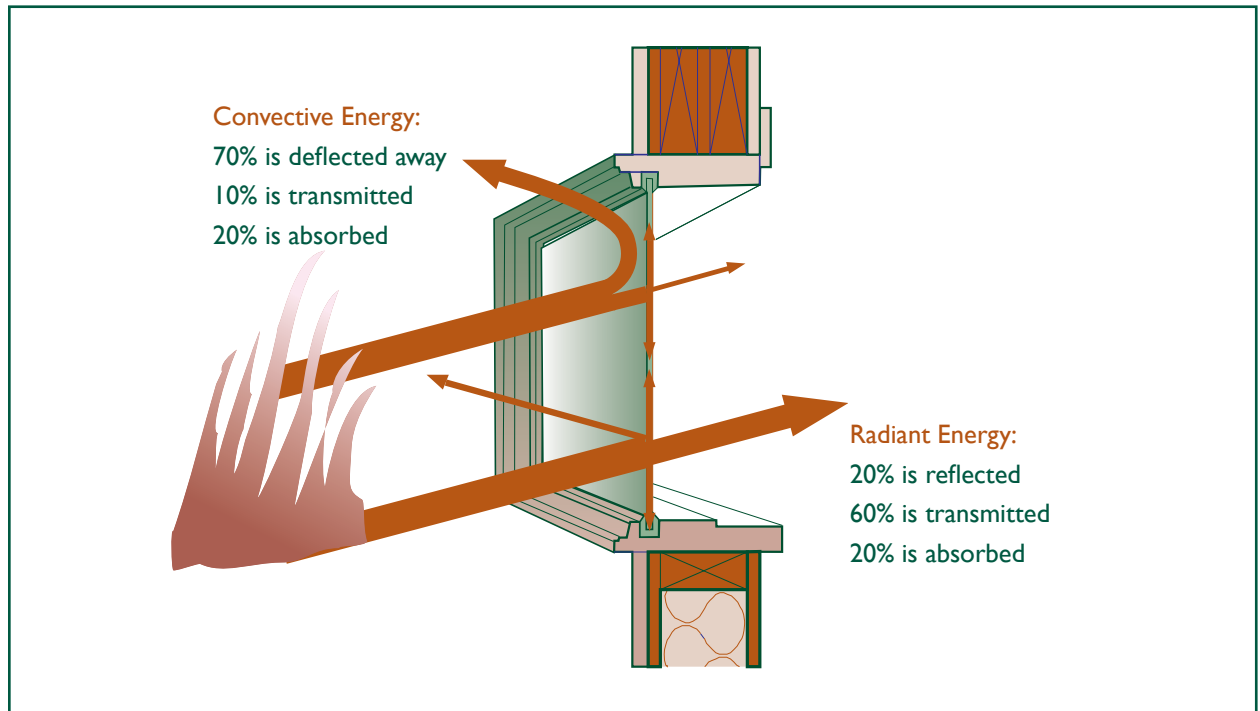

Energy transmission, conventional glass

Large and small windows

Even if the glass does fracture, the hot gasses (convective energy) from the fire and the fire itself cannot enter the building if the glass stays in place. Only the radiant energy heat can get through. Eventually, even with the glass in place, combustible materials behind the window may ignite. (See Low E glass).

Small windows, less than 2 feet wide or tall on a side, will keep fractured glass in place. The size of glass held in place by the sash is relatively small with little weight.

Large windows (more than 2 feet wide or tall on a side) cannot keep the fractured glass in place. The size and weight of glass in relationship to the length of sash is too great.

Thermopane or double glazed windows

Because of current energy codes, most glass today is double glazed or Thermopane. Double-glazed windows last about twice as long as a single pane, or about 10 minutes.

The same processes of convective and radiant energy affect the front pane of glass. As long as the front pane is in place, the second pane is partially protected. When the front pane fails and falls away, the process continues on the second pane until it fails and falls away.

As shown earlier in the fire behavior section, the duration of a fire at a site is dependent on the slope and the fuels. It can be as short as 5 minutes in the case of a grass fire.

If the duration of the fire is any longer than 10 minutes due to significant fuel

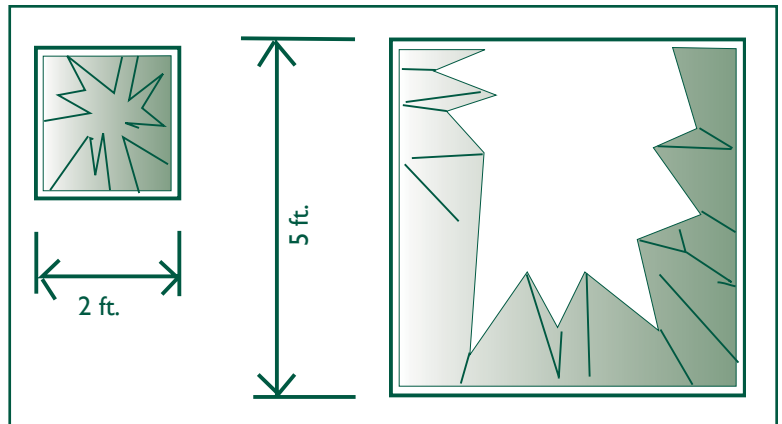

Small and large windows

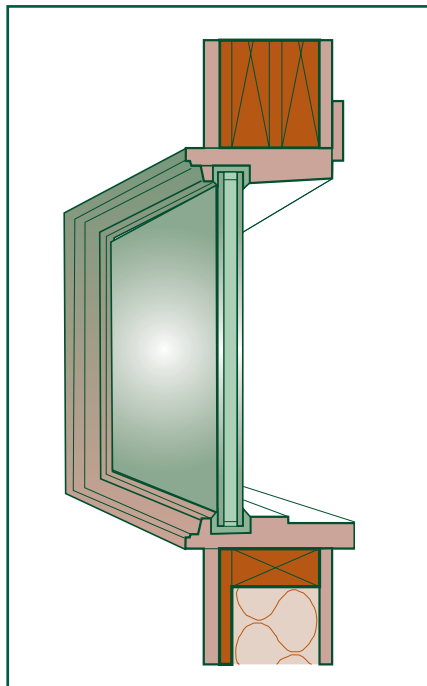

Thermopane window

supply around the house or preheating, additional protection will be necessary to prevent glass failure and fire entering the house.

Exterior window covers, shutters and screens

Only an additional 10 to 20 minutes of protection is necessary for a window to survive most fires. Exterior window covers, such as in-place shutters, can add this time. Shutters originated in New England as protection from storms when the wind would break the glass. They are now readily available in the Southeast for hurricane protection.

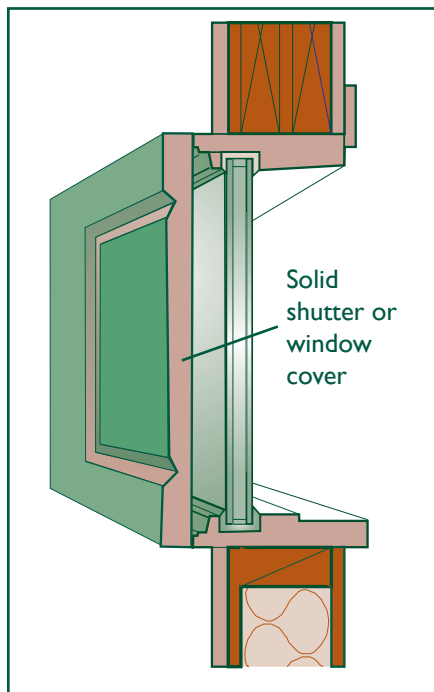

Wood shutters are the most common and economical, but they will ignite within five minutes. However, as shown in the fire behavior section, if the wildland fire duration is short enough, an additional five minutes of protection may be all that is needed. Also, even though fire departments may use foam to protect structures, it will not stick to glass. Therefore, shutters may still be advisable.

Metal shutters are better. They will protect the window long enough to last through the fire event and will not ignite.

The disadvantage of shutters is that they are not completely passive, that is, they require intervention on the part of the homeowner or the fire department to work.

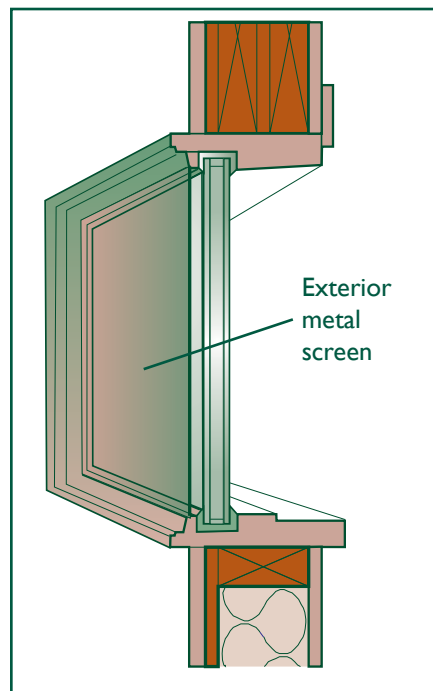

Permanently placed exterior metal screens eliminate the deployment problem. Exterior screens are not going to protect the window as much as a solid cover, but as mentioned before, only five to 10 minutes of additional protection may be needed. Screens also provide a surface to which foam can adhere. These screens cannot be used with outward acting windows, like casement or awning windows, but they can be used with horizontal sliding and double hung windows.

Tempered glass

Tempered glass is both resistant to high impact and high heat. Most of us are familiar with it. Building codes require that tempered glass be used in patio doors and all areas subject to human impact. It is also the glass used in front of fireplaces. Tempered glass will stay in place and intact throughout the wildland fire event.

A problem with tempered glass is cost. Windows with tempered glass typically cost 50 percent more than regular glass. There are strategies around this, and costs are coming down.

Patio door replacement units are, as they infer, used to replace glass in patio doors. These units are mass produced and stocked by virtually every glass business. As a result they are very economical. In fact they are less expensive than conventional glass. They come in six sizes, as shown at right, and typically can be used as a picture unit, or combined to make a window wall or solar structure.

Using patio door replacement units provides a lot of tempered glass at a very economical price.

A few brands of windows are marketed as replacement windows in existing mid-rise urban buildings where the use of tempered glass is required. As a result, the additional cost for these brands of tempered glass is only 25 percent more than standard glass. Your local window supplier can suggest appropriate manufacturers.

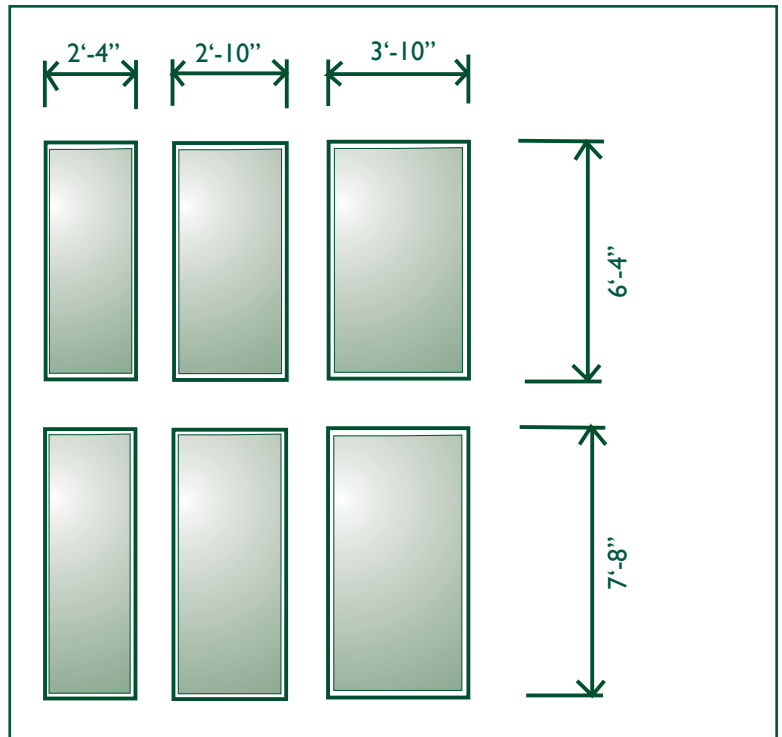

Patio door replacement unit sizes

Low E glass

Low E stands for low emissivity. This is an ultra thin, several microns thick, metallic coating on glass that appears white or reflective to infrared and ultraviolet light. It is used in windows for energy efficiency because it holds more heat in during the winter and keep more heat out during the summer. It also protects fabrics from fading and wood from yellowing.

This glazing option is widely used in windows today and only costs about 10 percent more than standard double glazed units.

The advantage of this glass in a wildland fire is that it stops the radiant energy

transfer to combustible materials behind the glass such as drapes, wood furniture and walls.

The combination of Low E and tempered glass features for windows provides the best possible solution for windows in a wildland fire. The glass will stay intact throughout the fire event and will transfer less radiant energy to combustibles in the structure.

It should be noted that the use of tempered and Low E glass is a recommendation based on observations in the field. Actual laboratory studies in a wildland fire setting need to be conducted to give these types of glass specific quantitative values.

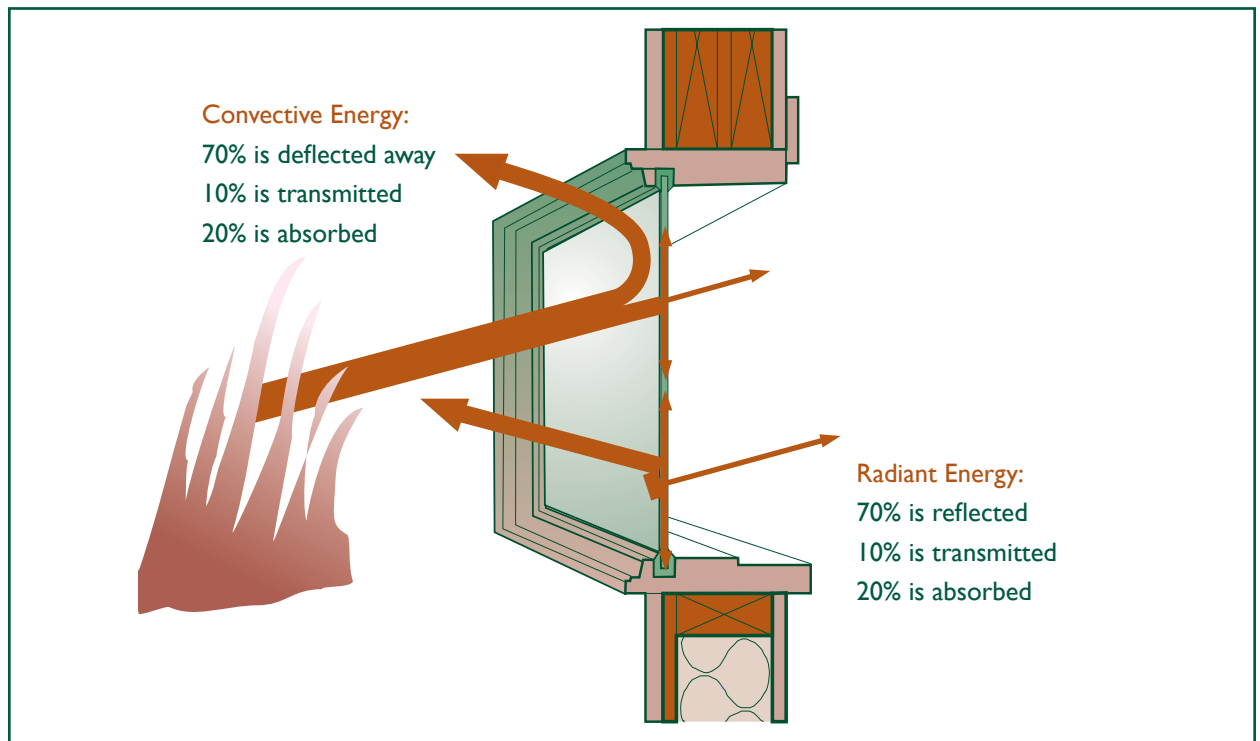

Energy transmission, Low E glass

Glass block

Glass block is the most fire- resistant glass available. It has the highest available rating of 90 minutes. It has an excellent appearance but provides a poor view. It does not have the Low E option.

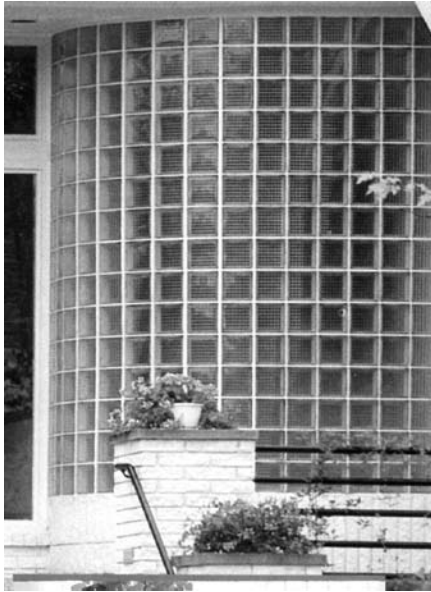

A good use may be in a situation where only day lighting is needed, a view is not a factor and the orientation of the window may be toward a very high fire hazard.

Frames and sashes

Windows with improved glass technology will only work as long as the glass remains in place. The glass is held in place by the frame, so the frame needs to withstand the fire.

Wood frames will burn. Since they have a high surface-to-volume ratio they will readily ignite and burn freely. They are not a good choice.

Vinyl frames seldom ignite, and if they do, the combustion rate is very slow.

It does not contribute to the combustion of the house. The problem is that vinyl frames melt and structurally fail, allowing the glass to fall away. They are not a good choice either.

Aluminum clad wood frames delay the ignition of the wood frame. They do not completely protect the window because the aluminum conducts the heat to the wood. This delay is enough in most wildland fires.

All aluminum frames are even better. Since there are no combustible materials, they remain fully intact during a fire. These frames are now available with a thermal break, a plastic spine that connects the interior frame to the exterior frame.

Doors

Wood doors

Residential buildings typically use wood doors with glass inserts. The same fire issues related to window glass apply to glass in doors. An unrated wood door is typically 1 1/2 to 2 inches thick. It can readily ignite and burn through in only 10 minutes, which is much faster than the rest of the structure will burn.

Wood doors are available with a class C, 20 minute rating. These doors are typically used between the garage and the house. They are a good solution in moderate fire hazard situations. In very high fire hazard situations, they may not resist burning for the fire duration and will allow other exterior building components to ignite.

Metal doors, steel and aluminum

Metal doors are non-combustible and available with 20 minute, 45 minute and one and one half-hour ratings, which makes them the most appropriate solution for very high hazard situations. Glass sizes are restricted in these doors. The surfaces are available with embossing to simulate wood grain and raised panel designs.

Just as in energy conservation, a good fire-resistive door requires adequate weatherstripping so that the seal prevents hot gasses or burning embers from entering the building.

6. Summary

A major wildfire can be an overwhelming event to experience. It can be huge, blotting out the sun and creating its own winds. It can throw flames and burning embers everywhere. Wildfire is a natural part of our environment that we can either respect or fear. If we make adjustments and modifications to our homes and the sites they occupy, then we can live confidently with fire. Each Interface resident must understand the basic characteristics of wildland fire and how it puts their property and lives at risk. Then the actions they take by building appropriate structures and properly caring for their Interface environment can significantly reduce the fire hazard.

A comparison is often made between fire and water. Fire, like water, tries to find a way into our homes. It does not matter how fire-resistant some parts of a structure are if weak points let a fire in. An awareness of how each building component is affected by fire will enable the owner, architect or builder to eliminate those weak points.

And finally, each of us needs to understand that, when we suppress wildland fires we must enhance our forest management policy to reduce fire fuels. When fires do occur they will be more manageable and less destructive to both the forest and our buildings.

References and additional information

The following is a partial list of publications and/or organizations can provide more information on this topic.

California's I-Zone

Rodney Slaughter, editor.

Available from the CFESTES bookstore in the California State Fire Marshal's Office, 1131 S St., Sacramento, California 95814.

Ph: 916-445-8200

Brushfire Prone Areas: Siting and Design of Residential Buildings

Construction of Buildings in Bushfire Prone Areas

Queensland Department of Local Government and Planning

P.O. Box 187, Brisbane Albert Street Qld 4002, Australia

Ph: 07-3237-1703, Fax: 07-3235-4071

The Urban Wildland Interface Code

The International Fire Code Institute, International Conference of Building Officials

5360 Workman Mill Road, Whittier, California 90601-2298

Ph: 562-699-0541

NFPA 299 Standard for Protection of Life and Property from Wildfire

National Fire Protection Association, (NFPA) 11 Tracy Drive, Avon, Massachusetts 02322

Ph. 800-344-3555

www.firewise.org

a web site maintained by NFPA covers much of what is in this pamphlet.